

INFRASTONE CABINETS

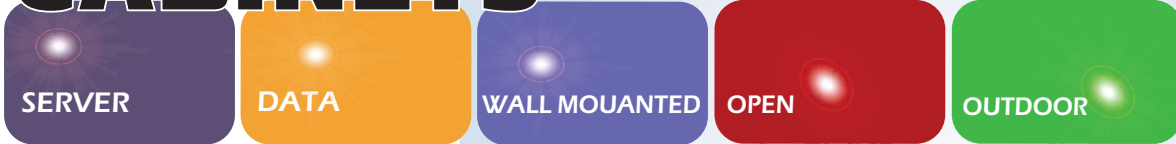

& More Racks Accessories



UNLIMITED USAGE

Optimize cable and thermal management for improved network availability with scalable, high-capacity solutions that protect, manage and showcase your network investment



BSC CABINET P/N:BSC

P/N:BSC



BSC CABINET
CABINET & ENCLOSURE

STANDARD

Comply with ANSI/EIARS-310-D, DIN41491; PART1, IEC297-2, DIN41494; PART7, GB/T3047.2-92 standard. Compatible with metric ETSI and 19 inch international standard.

FEATURES

- Exquisite design with precise craftsmanship
- Good compatibility, adapt to more servers. Perfect ventilation
- Vented front door and rear door enable ventilation and reliable operation
- The top and bottom wiring channel can be closed and adjusted.
- Optional plinth to meet under base wiring, ventilation and rat-proof
- Rack's side panel can be easily assembled.
- Efficient and solid cabinet connection
- Adjustable feet and heavy duty castors are available at the same time , static loading: 800kg.(with adjustable feet).
- Advanced lock
- Surface finish: degreasing, pickling, phosphating, powder coating
- Available in black and gray
- Height, width, and depth selectable, full range of optional accessories.

MATERIALS

Cold-rolled steel sheet. Thickness for frame 1.2mm, mounting rail 2.0mm(1.5mm for 600mm depth cabinet), fixed shelf 1.2mm , side panel 1.2mm. Thickness for smoky grey glass 5mm.

APPLICATION

Widely applied in finance, securities and data center; adopted by the professional servers' network providers as IBM, SUN, HP, COMPAQ, DELL etc.



Crescent lock



asily assembled side panel



Symmetrical frame



Fixed shelf



Cooling fan



Bottom plate



Mounting rail with U mark



Rectangle venthole

ASSEMBLING DRAF

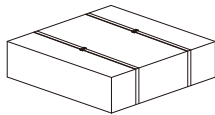

Package a:
(top cover and bottom plate,
mounting angle, fan tray, shelf, accessories bag)

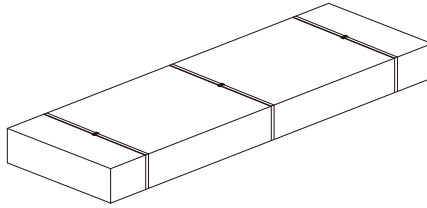

Package b:
(side panel, mounting rail, rear door, front door)

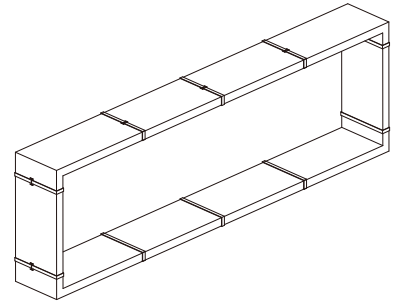

Package c: (frame)

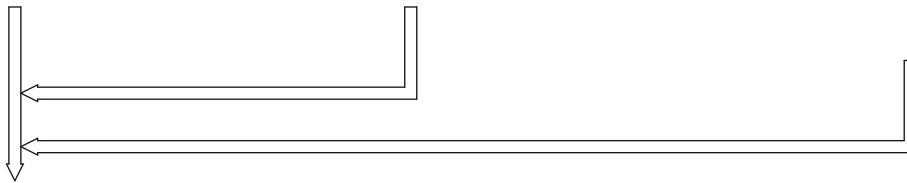
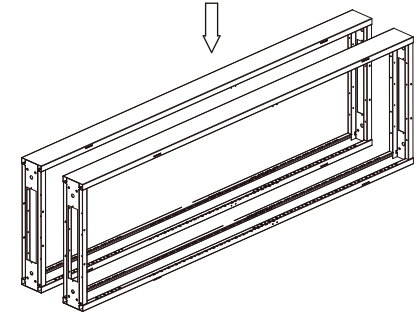
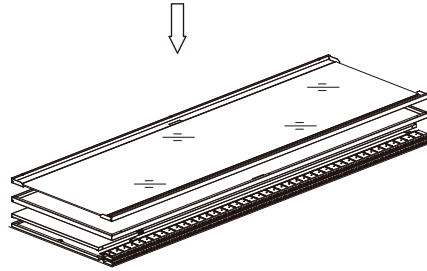
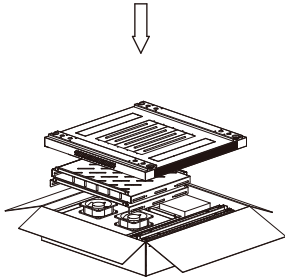

Before packing

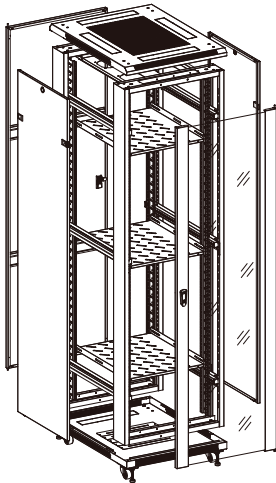

after packing

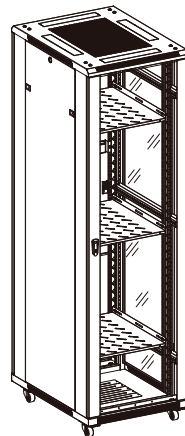

STRUCTURAL

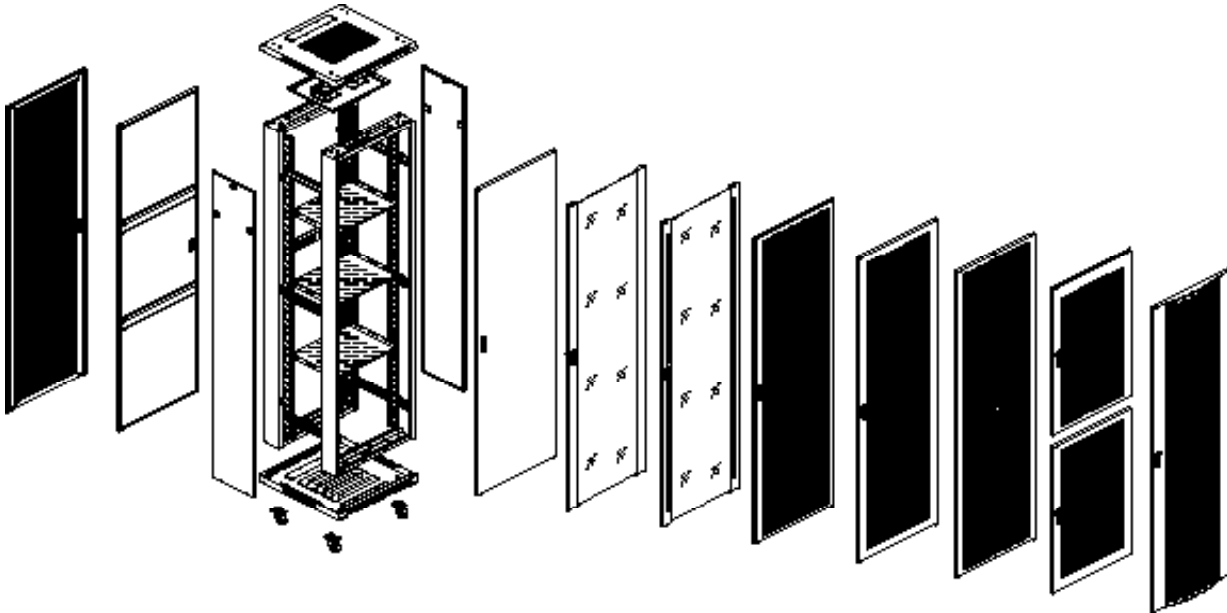

BSC CABINET
CABINET & ENCLOSURE

mm Unit of Measurement:mm

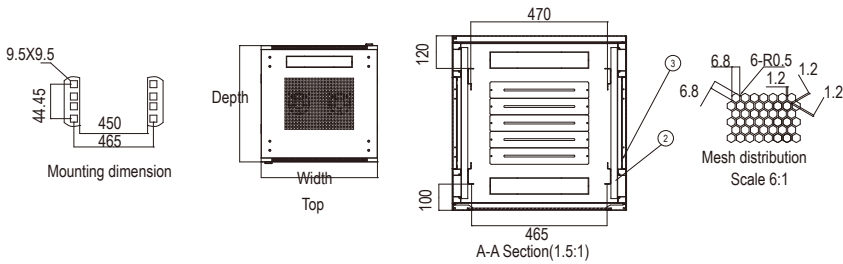
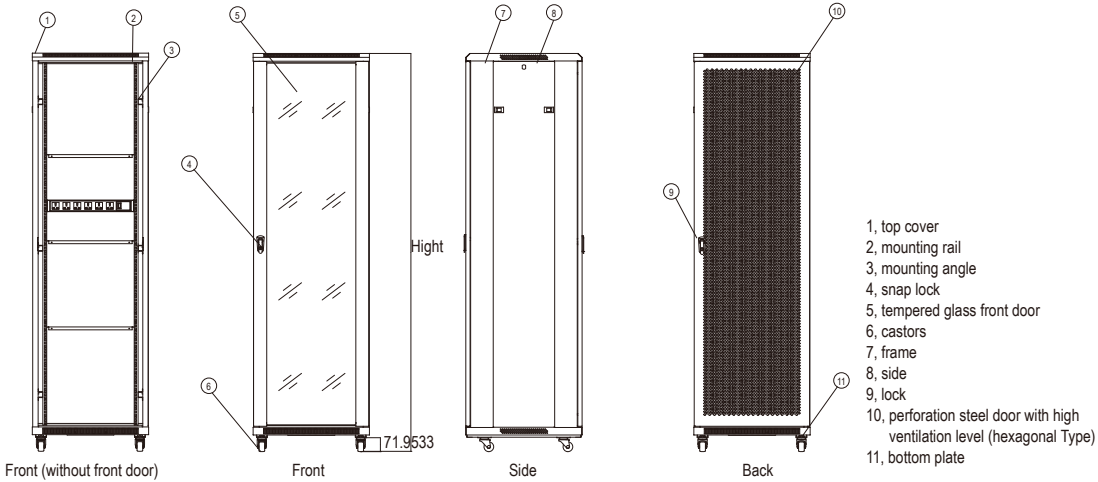

STANDARD ACCESSORIES

S/N	Specification	Qty	Unit	Material	surface finish	Remark
1	Top cover	1	Pcs	1.2mm cold rolled steel	Powder coated	---
2	Frame (nine-fold section steel)	2	Pcs	1.2mm cold rolled steel	Powder coated	---
3	Front door	1	Pcs	1.2mm cold rolled steel	Powder coated	type door
4	Side panel	4	Pcs	1.2mm cold rolled steel	Powder coated	With lock
5	Left rear door	1	Pcs	1.2mm cold rolled steel	Powder coated	A type door
6	Lock	1	Pcs	---	---	---
7	Mounting rail	6	Pcs	2.0mm cold rolled steel	Powder coated	1.5mm for 66
8	Mounting angle	4	Pcs	1.2mm cold rolled steel	Powder coated	---
9	Bottom plate	6	Pcs	1.2mm cold rolled steel	Powder coated	---
10	Spacer	2	Pcs	---	---	Width 800mm
11	Fixed shelf	1	Pcs	1.2mm cold rolled steel	Powder coated	2pcs under 32u, 1pcs under 22u
12	Heavy duty castors	4	Pcs	---	---	---
13	Feet	4	Pcs	---	---	---
14	Cage and nuts	40	sets	---	---	20pcs under 32u
15	Fan	4	Pcs	---	---	4fans for 600mm depth
16	PDU 8WAY	1	Pcs	---	---	---
17	Wrench	1	Pcs	---	---	---



BSC CABINET P/N: BSC

ORDER INFORMATION BSC

Part No	Capacity/U	Width/mm	Depth/mm	Height/mm	Carton measurement			Volume/CBM
					Width/m	Depth/m	Height/m	
	18U	600	600	988	0.63	0.63	1.02	0.40
BSC U SIZE -W-D	22U	600	600	1166	0.63	0.63	1.20	0.48
		600	800		0.63	0.83		0.63
BSC U SIZE -W-D	27U	600	600	1388	0.63	0.63	1.42	0.56
	32U	600	600	1610	0.63	0.63	1.64	0.65
BSC U SIZE -W-D		600	800		0.63	0.83		0.86
	37U	600	600	1833	0.63	0.63	1.86	0.74
		600	800		0.63	0.83		0.97
BSC U SIZE -W-D		600	1000		0.63	1.04		1.22
		800	800		0.83	0.83		1.28
		800	1000		0.83	1.04		1.61
	42U	600	600	2055	0.63	0.63	2.08	0.83
		600	800		0.63	0.83		1.09
		600	1000		0.63	1.04		1.36
BSC U SIZE -W-D		600	1100		0.63	1.14		1.49
		600	1200		0.63	1.24		1.62
		800	600		0.83	0.63		1.09
		800	800		0.83	0.83		1.43
		800	1000		0.83	1.04		1.80
	47U	600	600	2277	0.63	0.63	2.30	0.91
		600	800		0.63	0.83		1.20
BSC U SIZE -W-D		600	1000		0.63	1.04		1.51
		800	800		0.83	0.83		1.58
		800	1000		0.83	1.04		1.99



* Front door = Rear door = #



COLOR

BLACK

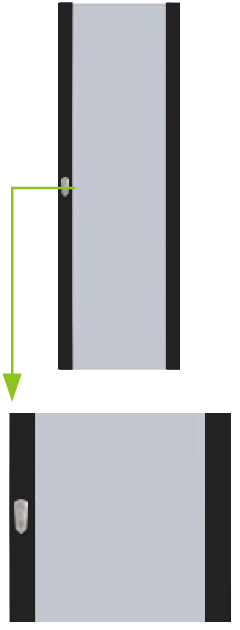
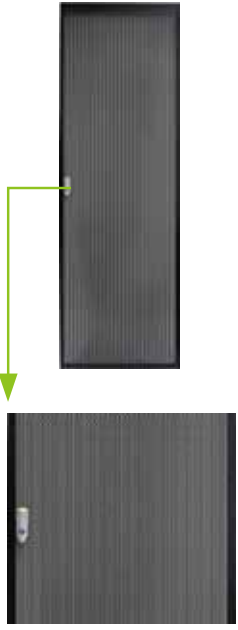

DOORS

A= steel casement door	B= smoky-gray glass door	D= perforation steel door	F= double swing steel door (perforated)
 <p>Diagram showing a solid black steel casement door. A green arrow points from the top hinge area down to a close-up view of the door's handle and locking mechanism.</p>	 <p>Diagram showing a smoky-gray glass door with a black frame. A green arrow points from the top hinge area down to a close-up view of the door's handle and locking mechanism.</p>	 <p>Diagram showing a perforated steel door with a black frame. A green arrow points from the top hinge area down to a close-up view of the door's handle and locking mechanism.</p>	 <p>Diagram showing a double swing steel door with a perforated pattern and a black frame. A green arrow points from the top hinge area down to a close-up view of the door's handle and locking mechanism.</p>

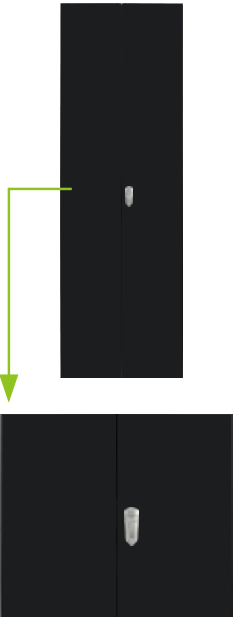
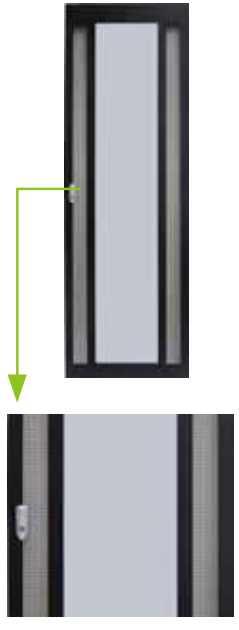
H= curved concavo-convex perforation steel door (hexagonal Type)	I= concavo-convex perforation steel door (hexagonal Type)	J= double swing steel door	N= Smoky-gray glass door with both sides punched
 <p>Diagram showing a curved concavo-convex perforation steel door with a hexagonal pattern and a black frame. A green arrow points from the top hinge area down to a close-up view of the door's handle and locking mechanism.</p>	 <p>Diagram showing a concavo-convex perforation steel door with a hexagonal pattern and a black frame. A green arrow points from the top hinge area down to a close-up view of the door's handle and locking mechanism.</p>	 <p>Diagram showing a double swing steel door with a black frame. A green arrow points from the top hinge area down to a close-up view of the door's handle and locking mechanism.</p>	 <p>Diagram showing a smoky-gray glass door with a black frame and punched sides. A green arrow points from the top hinge area down to a close-up view of the door's handle and locking mechanism.</p>