

BlackStone Standalone Cabinets BSC

BSC CABINET



FEATURES

- Exquisite design with precise craftsmanship.
- Good compatibility, adapt to more servers.
- Perfect ventilation vented front door and rear door enable ventilation and reliable operation.
- The top and bottom wiring channel can be closed and adjusted.
- Optional plinth to meet under base wiring, ventilation and rat-proof Rack's side panel can be easily assembled.
- Efficient and solid cabinet connection.
- Adjustable feet and heavy duty castors are available at the same time , static.
- loading: 800kg.(with adjustable feet).
- Advanced lock.
- Surface finish: degreasing, pickling, phosphating, powder coating Available in black and gray Height, width, and depth selectable.
- Full range of optional accessories.

STANDARD

Comply with ANSI/EIARS-310-D, DIN41491; PART1, IEC297-2, DIN41494; PART7, GB/T3047.2-92 standard. Compatible with metric ETSI and 19-inch international standard

MATERIALS

Cold-rolled steel sheet. Thickness for frame 1.2mm, mounting rail 2.0mm (1.5mm for 600mm depth cabinet), fixed shelf 1.2mm, side panel 1.2mm. Thickness for smoky grey glass 5mm. Tempered smoky-gray glass with thickness of 5mm.

APPLICATION

Widely applied in finance, securities, and data center; adopted by the professional servers' network providers as IBM, SUN, HP, COMPAQ, DELL etc.

STRUCTURAL

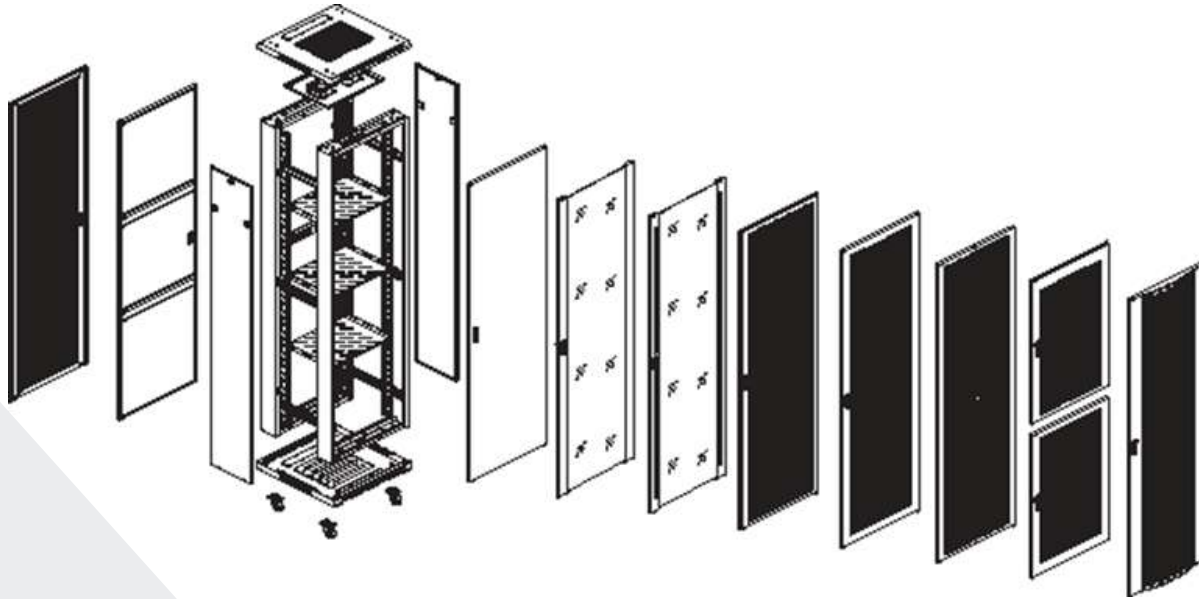

DIMENSION (MM)

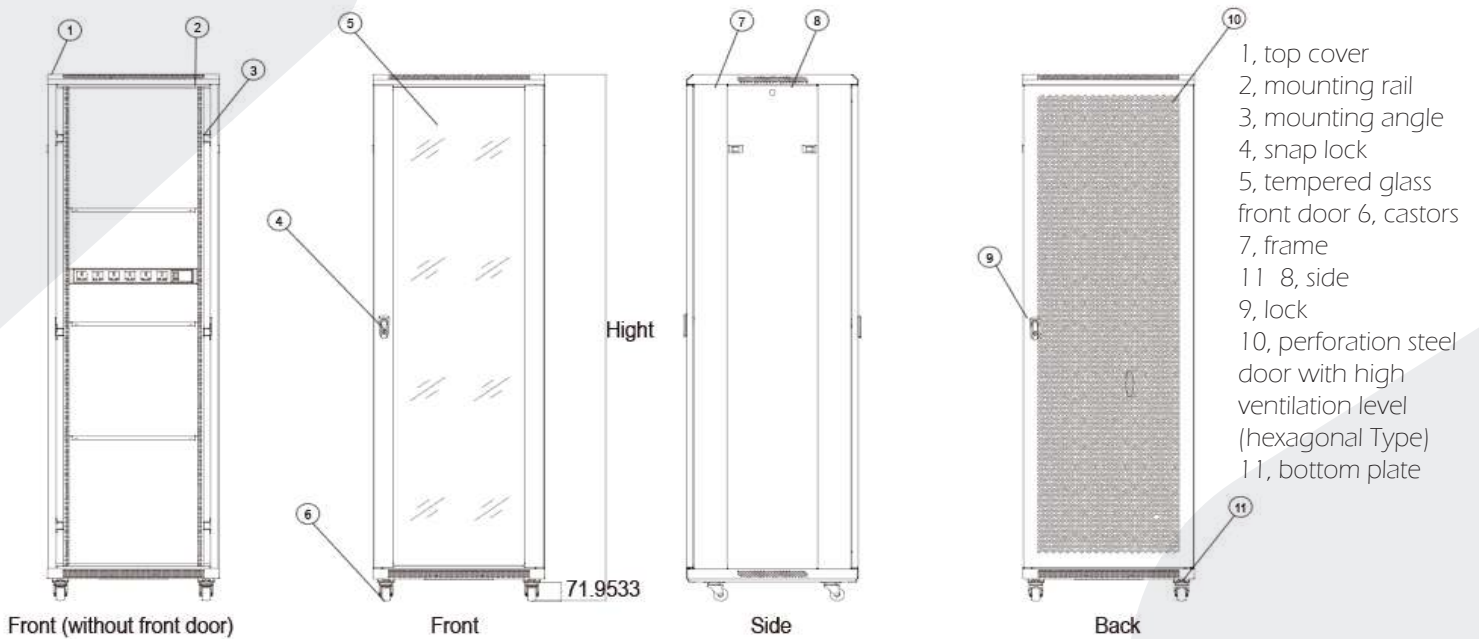

Front (without front door)

Front

Side

Back

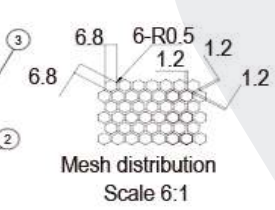
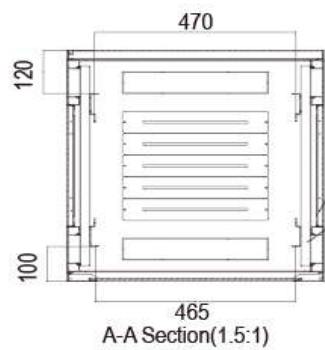
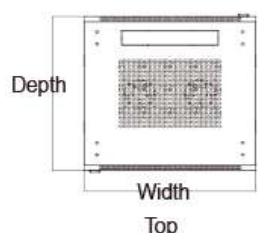
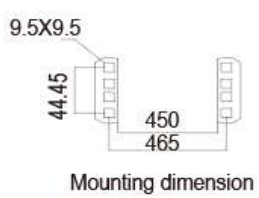



Cut-outs in the top
allow for efficient routing of cables into the cabinet.



vertical cable trunk
provides additional cable management.



Doors
All doors are reversible and equipped with locking rotating latches.



Lockable side panels
Are removable with handle for better handling.



Curved perforated door
Are also available and provides maximum floor space utilization



Cabinet base
is open to allow fresh airflow within the cabinet.



heat management
for high-density server installations, a fan door is available.



Doors
Are removable with locking latches and do not require tools.



Cabinet fans
Cabinets are equipped with four top mounting fans to help airflow for sever



Cabinets
Are equipped with solid levelers and multi-directional casters.



Fixed shelf for permanent installation



Sliding shelf for easy access to equipment



Cantilever Slab with front rackmount.



Keyboard panel For regular size keyboard is available with or without top



Mounting rail with U mark



Crescent lock



Rectangle venthole



Easily assembled. side panel



Bottom plate



Fixed shelf



Symmetrical frame

STANDARD ACCESSORIES

S/N	Specification	Qty	Unit	Material	surface finish	Remark
1	Top cover	1	Pcs	1.2mm cold rolled steel	Powder coated	--
2	Frame (nine-fold section steel)	2	Pcs	1.2mm cold rolled steel	Powder coated	--
3	Front door	1	Pcs	1.2mm cold rolled steel	Powder coated	B Type door "13"
4	Side panel	4	Pcs	1.2mm cold rolled steel	Powder coated	With lock
5	back door	1	Pcs	1.2mm cold rolled steel	Powder coated	A type door
6	Lock	1	Pcs	--	--	--
7	Mounting rail	6	Pcs	2.0mm cold rolled steel	Powder coated	--
8	Mounting angle	4	Pcs	1.2mm cold rolled steel	Powder coated	--
9	Bottom plate	6	Pcs	1.2mm cold rolled steel	Powder coated	--
10	Spacer	2	Pcs	--	--	Width 800mm
11	Heavy duty castors	4	Pcs	--	--	--
12	Feet	4	Pcs	--	--	--
13	Cage and nuts	40	sets	--	--	20pcs under 32u
14	Wrench	1	Pcs	--	--	--

ORDER INFORMATION

PART NUMBER	Capacity/U SIZE	Width(mm)	DEPTH (mm)	Standers Accessories information included		
				Fans	shelf	PDU
18U				✓	✓	✓
BSC18-66	18	600	600	4	2	1
22U				✓	✓	✓
BSC22-66	22	600	600	4	2	1
BSC22-68	22	600	800	4	2	1
BSC22-610	22	600	1000	4	2	1
27U				✓	✓	✓
BSC27-66	27	600	600	4	2	1
BSC27-68	27	600	800	4	2	1
BSC27-610	27	600	1000	4	2	1
42U				✓	✓	✓
BSC42-66	42	600	600	4	3	1
BSC42-68	42	600	800	4	3	1
BSC42-88	42	800	800	4	3	1
BSC42-810	42	800	1000	4	3	1
BSC42-812	42	800	1200	4	3	1

Please contact us for customized requirement

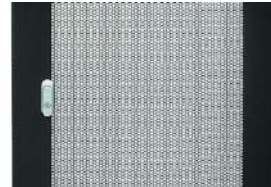
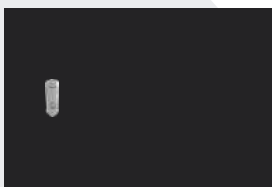
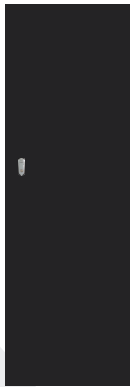

Steel casement door

Smoky-gray glass door

Perforation steel door

Double swing steel door (perforated)

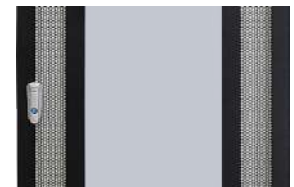
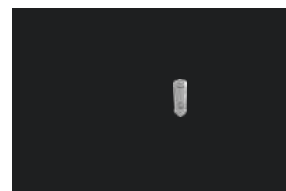
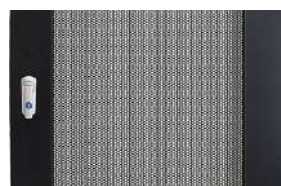
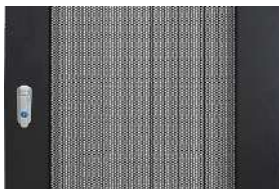
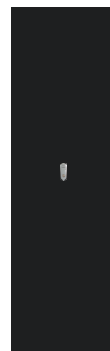

Curved concavo-convex perforation steel door

Concave-convex perforation steel door (hexagonal Type)

Double swing steel door

Smoky-gray glass door with both sides punched